

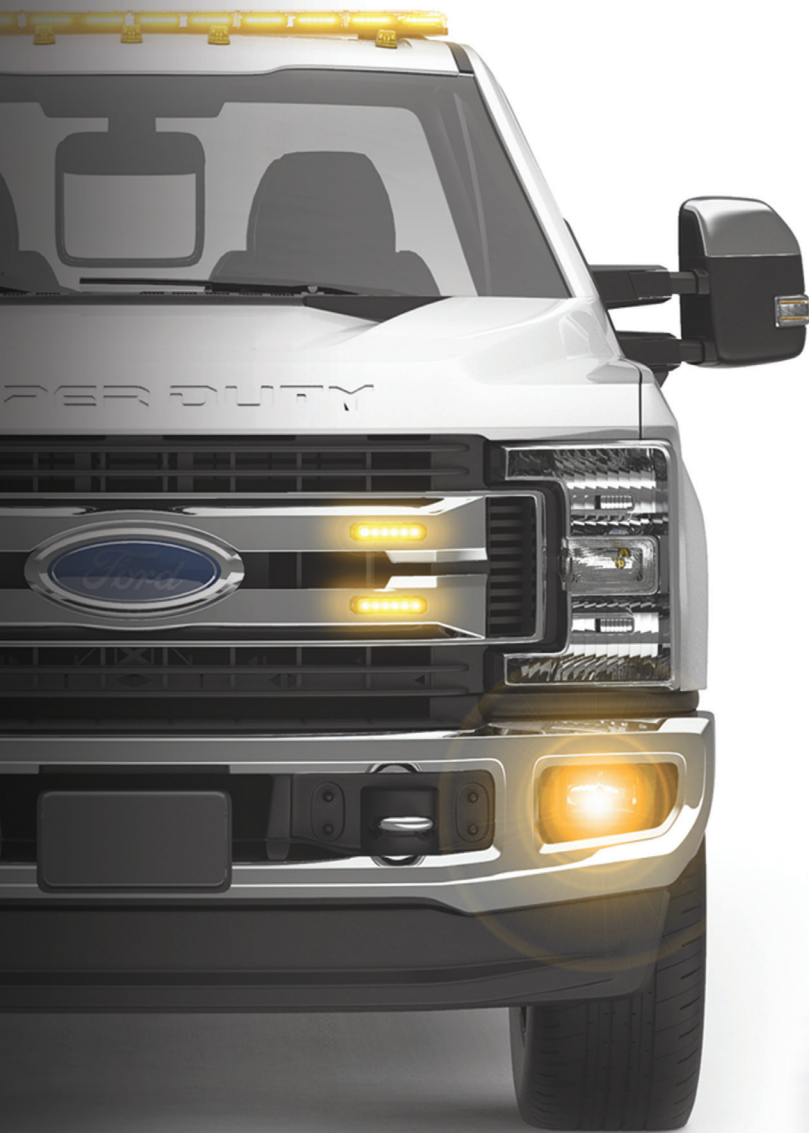

# SPEEDTECH LIGHTS®

LIGHTING THE WAY®



**2024 CATALOG**  
[WWW.SPEEDTECHLIGHTS.COM](http://WWW.SPEEDTECHLIGHTS.COM)

# TABLE OF CONTENTS

- 3 ABOUT
- 4 PRODUCT FEATURES
- 6 VISOR LIGHT BARS
- 8 DECK/DASH LIGHTS
- 10 TRAFFIC ADVISORS
- 12 GRILLE/SURFACE MOUNTS
- 15 HIDEAWAY/SURFACE MOUNTS
- 16 RUNNING BOARD LIGHTS
- 17 BEACONS
- 18 MINI LIGHT BARS
- 20 FULL LIGHT BARS
- 23 TOW LIGHT BARS
- 24 OFF ROAD/WORK LIGHTS
- 31 TAILGATE LIGHTS
- 32 SIRENS
- 34 SPEAKERS
- 35 ROADSIDE SAFETY
- 36 SWITCH BOXES
- 40 FLASHLIGHTS
- 41 MOUNTING BRACKETS
- 46 WEBSITE FEATURES



## OUR MISSION:

To ensure the safety of first responders, public safety professionals, and the general public by providing reliable and affordable warning lights and equipment, delivered fast with the highest level of service.

## OUR PURPOSE:

SpeedTech Lights was founded for the purpose of providing quick and easy access to high-quality and affordable emergency vehicle lighting and equipment.

Based in Buda, Texas, our goal is to provide safety and eliminate risks while on the job with bright, effective lighting. We carry a wide variety of warning lights and sirens as well as a large selection of off-road and scene lighting, all utilizing advanced LED lighting technology and innovative designs for many applications.

We make sure high-quality warning lights and equipment are accessible to any department, any company, any business, large or small, and ensure it gets to you fast. Here at SpeedTech Lights, we work hard, we work smart, we work together, we love what we do, and we highly respect our customers. No matter who you are... when you come to SpeedTech Lights, you are always our most important customer.

Thank you to all of our every day heroes for your service.



# STL ECLIPSE<sup>®</sup> OPTIC TECHNOLOGY

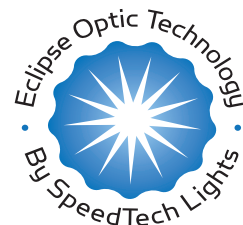

## ECLIPSE<sup>®</sup> TIR OPTICS:

TIR Optics produce a highly concentrated beam of light for each individual LED creating a layering of light output as a result. This allows the TIR Optics to offer performance with fewer LEDs per module & a more precise focal output.

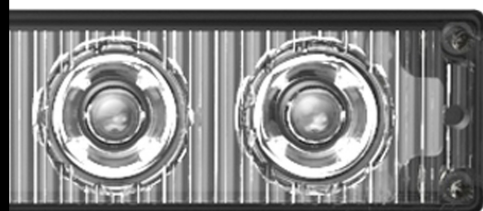

### Specs:

- 70° horizontal spread
- 20° vertical spread

## ECLIPSE<sup>®</sup> LINEAR OPTICS:

Linear Optics produce a wide broad beam of light for each LED module. With powerful magnification, Linear Optics create ultra-wide light dispersal, allowing for greater off-axis visibility.

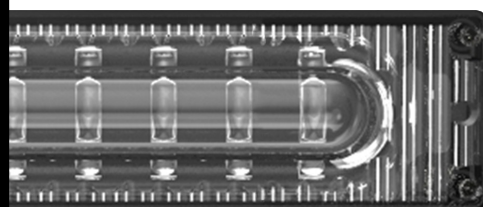

### Specs:

- 110° horizontal spread
- 20° vertical spread

## AVAILABLE CARBINE OPTICS



### FLOODLIGHT OPTICS



Floodlight Optics provide a wide spread of light to better illuminate nearby areas.

### HYBRID OPTICS



Hybrid Optics are comprised of both Floodlight & Spotlight Optics, providing a balance between further visibility & wide light spread.

# STL MULTICOLOR LINEAR

All STL Linear products now come equipped with **MULTICOLOR** technology which features specialized flash patterns using dual color LED modules. These include **alternating color flash patterns**, specially designed for **MULTICOLOR** products, along with a few **single color flash patterns** of both primary & secondary LED colors. This lets you run more appropriate colors for different applications.

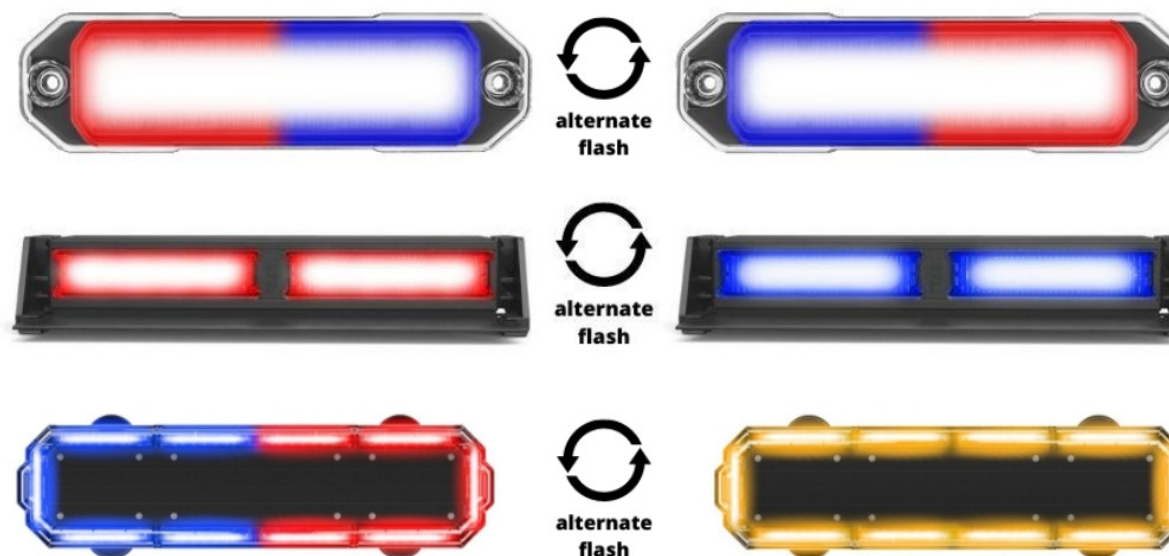

## OPTIONAL UPGRADES



### SUPER TAKE DOWN<sup>®</sup>



The Super Take Down upgrade converts all forward facing LED modules into MultiColor LED modules. This upgrade retains your Light Bar's warning colors in warning mode & activates Clear in Super Take Down mode.

### RED BRAKE LIGHT



The Red Brake Light upgrade converts LED modules into MultiColor LED modules. This upgrade retains your Light Bar's warning colors in warning mode & activates Red in Brake Light mode.

# STL RAPTOR-X TIR

SKU B-RTX8

DIMENSIONS PER SIDE 15.5" L x 1.2" H x 5.3" D

AVAILABLE COLORS 

### FEATURES

- Eclipse TIR optics
- 32 3-Watt LEDs
- 26 warning flash patterns with dual memory
- Built-in windshield reflector visor
- Optional Cigarette Plug with Control Switches (p. 38)



# STL RAPTOR TIR

SKU B-RT10 / B-RTSTD10

DIMENSIONS PER SIDE 18" L x 1.2" H x 5.3" D

AVAILABLE COLORS 

### FEATURES

- Eclipse TIR optics
- 40 3-Watt LEDs
- 26 warning flash patterns with dual memory
- Take down light functionality
- Built-in windshield reflector visor
- Optional STL Grand Control Switch Box (p. 36)



# STL ARC VISOR TIR

SKU B-AV2

DIMENSIONS 11" L x 4.75" H x 1" D

AVAILABLE COLORS 

### FEATURES

- Eclipse TIR optics
- 40 MaxGen LEDs
- 24 warning flash patterns
- Includes velcro straps for mounting to sun visor
- Power & flash pattern controls on unit
- Includes Cigarette Plug



# STL MULTICOLOR RAPTOR-X LINEAR

SKU B-RLXMC8

DIMENSIONS PER SIDE 15.5" L x 1.2" H x 5.3" D

AVAILABLE COLORS 

### FEATURES

- Eclipse Linear optics
- 64 3-Watt LEDs
- 36 warning flash patterns with dual memory
- Built-in windshield reflector visor
- Optional Cigarette Plug with Control Switches (p. 38)



# STL MULTICOLOR RAPTOR LINEAR

SKU B-RLMC10

DIMENSIONS PER SIDE 18" L x 1.2" H x 5.3" D

AVAILABLE COLORS 

### FEATURES

- Eclipse Linear optics
- 72 3-Watt LEDs
- 36 warning flash patterns with dual memory
- Take down light functionality
- Built-in windshield reflector visor
- Optional STL Grand Control Switch Box (p. 36)

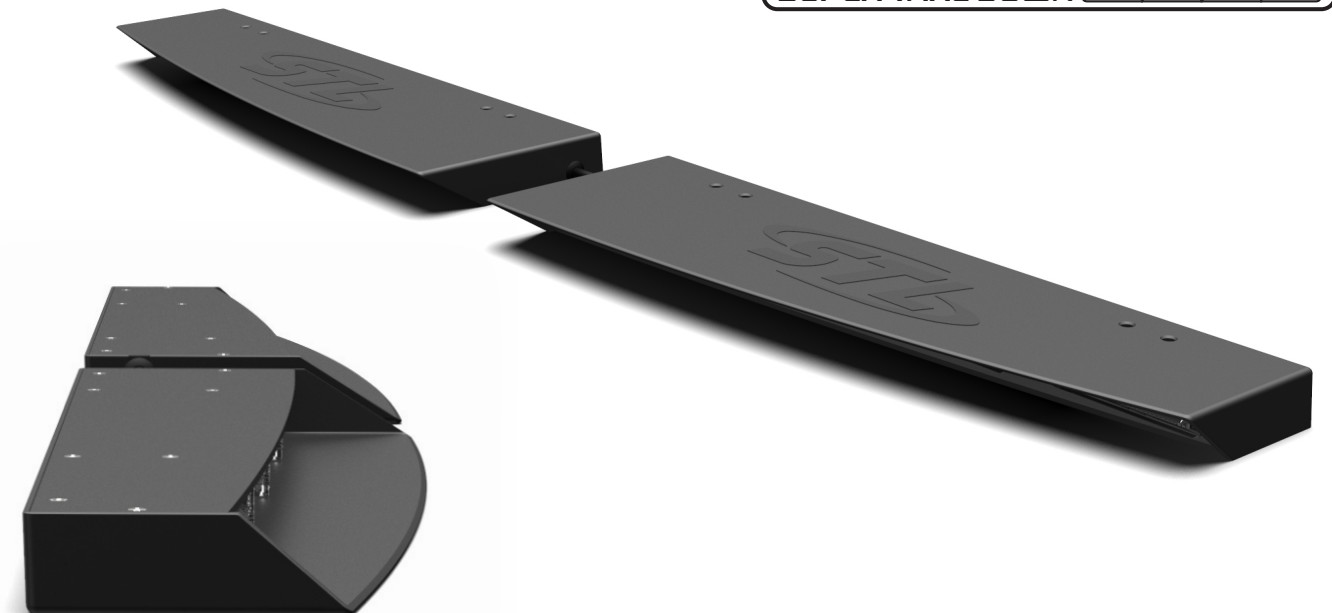

# STL STRIKER-1 TIR

**SKU B-STT1**  
**DIMENSIONS 4.1" L x 1.25" H x 2.25" D**  
**AVAILABLE COLORS**   
**FEATURES**

- Eclipse TIR optics
- 4 3-Watt LEDs
- 22 warning flash patterns with dual memory
- Optional Windshield Reflector Visor (p. 42)
- Optional Cigarette Plug with Control Switches (p. 38)



# STL STRIKER-2 TIR

**SKU B-STT2**  
**DIMENSIONS 8.25" L x 1.25" H x 2.25" D**  
**AVAILABLE COLORS**   
**FEATURES**

- Eclipse TIR optics
- 8 3-Watt LEDs
- 24 warning flash patterns with dual memory
- Optional Windshield Reflector Visor (p. 42)
- Optional Cigarette Plug with Control Switches (p. 38)



# STL STRIKER-4 TIR

**SKU B-STT4**  
**DIMENSIONS 16.25" L x 1.25" H x 2.25" D**  
**AVAILABLE COLORS**   
**FEATURES**

- Eclipse TIR optics
- 16 3-Watt LEDs
- 26 warning flash patterns with dual memory
- Optional Windshield Reflector Visor (p. 42)
- Optional Cigarette Plug with Control Switches (p. 38)

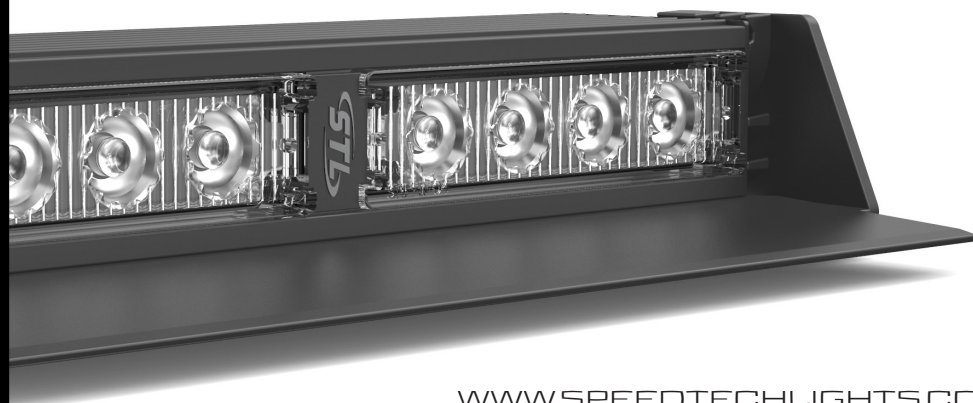

# STL MULTICOLOR VIRTUE-1 LINEAR

**SKU B-VLMC1**  
**DIMENSIONS 4.1" L x 1.25" H x 2.25" D**  
**AVAILABLE COLORS**   
**FEATURES**

- Eclipse Linear optics
- 10 3-Watt LEDs
- 24 warning flash patterns with dual memory
- Optional Windshield Reflector Visor (p. 42)
- Optional Cigarette Plug with Control Switches (p. 38)

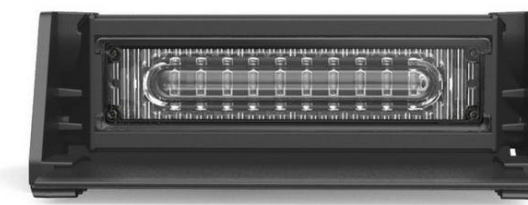

# STL MULTICOLOR VIRTUE-2 LINEAR

**SKU B-VLMC2**  
**DIMENSIONS 8.25" L x 1.25" H x 2.25" D**  
**AVAILABLE COLORS**   
**FEATURES**

- Eclipse Linear optics
- 20 3-Watt LEDs
- 34 warning flash patterns with dual memory
- Optional Windshield Reflector Visor (p. 42)
- Optional Cigarette Plug with Control Switches (p. 38)



# STL MULTICOLOR VIRTUE-4 LINEAR

**SKU B-VLMC4**  
**DIMENSIONS 16.25" L x 1.25" H x 2.25" D**  
**AVAILABLE COLORS**   
**FEATURES**

- Eclipse Linear optics
- 40 3-Watt LEDs
- 34 warning flash patterns with dual memory
- Optional Windshield Reflector Visor (p. 42)
- Optional Cigarette Plug with Control Switches (p. 38)

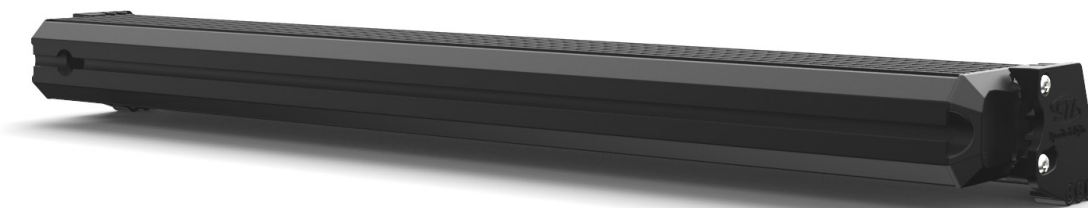

# STL STRIKER-6 TIR

SKU D-STT6 / D-STTMC6

DIMENSIONS 24.9" L x 1.25" H x 2.25" D

AVAILABLE COLORS 

### FEATURES

- Eclipse TIR optics
- 24 3-Watt LEDs
- 26 warning flash patterns with dual memory
- 9 directional flash patterns
- Optional Windshield Reflector Visor (p. 42)
- Optional STL Direct Control Switch Box (p. 36)



# STL STRIKER-8 TIR

SKU D-STT8 / D-STTMC8

DIMENSIONS 33.1" L x 1.25" H x 2.25" D

AVAILABLE COLORS 

### FEATURES

- Eclipse TIR optics
- 32 3-Watt LEDs
- 26 warning flash patterns with dual memory
- 9 directional flash patterns
- Optional Windshield Reflector Visor (p. 42)
- Optional STL Direct Control Switch Box (p. 36)



# STL DART TIR

SKU D-DRT16

DIMENSIONS 33" L x 16" H x 3" D

AVAILABLE COLORS 

### FEATURES

- Eclipse TIR optics
- 64 3-Watt LEDs
- 29 warning flash patterns with dual memory
- 8 directional flash patterns
- Optional STL Direct Control Switch Box (p. 36)

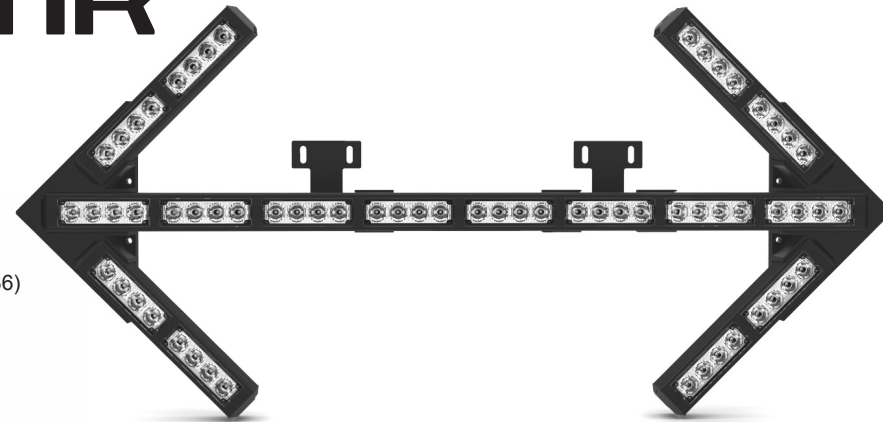

WWW.SPEEDTECHLIGHTS.COM

# STL MULTICOLOR VIRTUE-6 LINEAR

SKU D-VLMC6

DIMENSIONS 24.9" L x 1.25" H x 2.25" D

AVAILABLE COLORS 

### FEATURES

- Eclipse Linear optics
- 60 3-Watt LEDs
- 36 warning flash patterns with dual memory
- 9 directional flash patterns
- Optional Windshield Reflector Visor (p. 42)
- Optional STL Direct Control Switch Box (p. 36)



# STL MULTICOLOR VIRTUE-8 LINEAR

SKU D-VLMC8

DIMENSIONS 33.1" L x 1.25" H x 2.25" D

AVAILABLE COLORS 

### FEATURES

- Eclipse Linear optics
- 80 3-Watt LEDs
- 36 warning flash patterns with dual memory
- 9 directional flash patterns
- Optional Windshield Reflector Visor (p. 42)
- Optional STL Direct Control Switch Box (p. 36)



WWW.SPEEDTECHLIGHTS.COM

# STL Z-3 TIR

SKU G-TZT3  
DIMENSIONS 3.7" L x 1.6" H x .6" D  
AVAILABLE COLORS 

- FEATURES**
- Eclipse TIR optics
  - 3 3-Watt LEDs
  - 22 warning flash patterns
  - Built-in sync capability
  - 3 alternate sync pattern speeds
  - Weatherproof housing

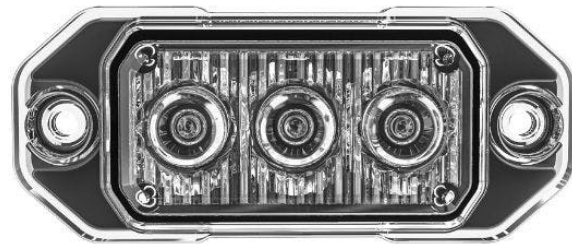

# STL Z-4 TIR

SKU G-TZT4  
DIMENSIONS 4.4" L x 1.6" H x .6" D  
AVAILABLE COLORS 

- FEATURES**
- Eclipse TIR optics
  - 4 3-Watt LEDs
  - 24 warning flash patterns
  - Built-in sync capability
  - 3 alternate sync pattern speeds
  - Weatherproof housing



# STL Z-6 TIR

SKU G-TZT6 / G-TZTSTD6 / G-TZTBL6  
DIMENSIONS 5.7" L x 1.6" H x .6" D  
AVAILABLE COLORS 

- FEATURES**
- Eclipse TIR optics
  - 6 3-Watt LEDs
  - 24 warning flash patterns
  - Built-in sync capability
  - 3 alternate sync pattern speeds
  - Weatherproof housing



**OPTIONAL UPGRADES**  
 SUPER TAKE DOWN   
 RED BRAKE LIGHT 

# STL ZX-180 TIR

SKU G-ZXT180  
DIMENSIONS 4.6" L x 1.6" H x 1.5" D  
AVAILABLE COLORS 

- FEATURES**
- Eclipse TIR optics
  - 6 3-Watt LEDs
  - 24 warning flash patterns
  - Built-in sync capability
  - 3 alternate sync pattern speeds
  - Weatherproof housing
  - Includes brackets for mounting



# STL MULTICOLOR Z-6 LINEAR

SKU G-LZMC6  
DIMENSIONS 3.7" L x 1.6" H x .6" D  
AVAILABLE COLORS 

- FEATURES**
- Eclipse Linear optics
  - 6 3-Watt LEDs
  - 24 warning flash patterns
  - Built-in sync capability
  - 3 alternate sync pattern speeds
  - Weatherproof housing

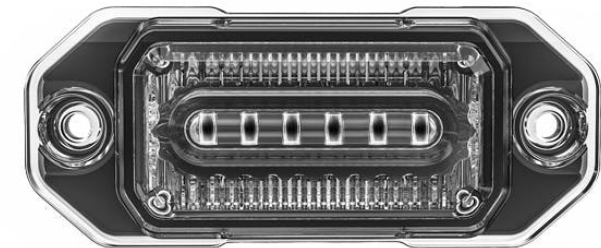

# STL MULTICOLOR Z-8 LINEAR

SKU G-LZMC8  
DIMENSIONS 4.4" L x 1.6" H x .6" D  
AVAILABLE COLORS 

- FEATURES**
- Eclipse Linear optics
  - 8 3-Watt LEDs
  - 34 warning flash patterns
  - Built-in sync capability
  - 3 alternate sync pattern speeds
  - Weatherproof housing

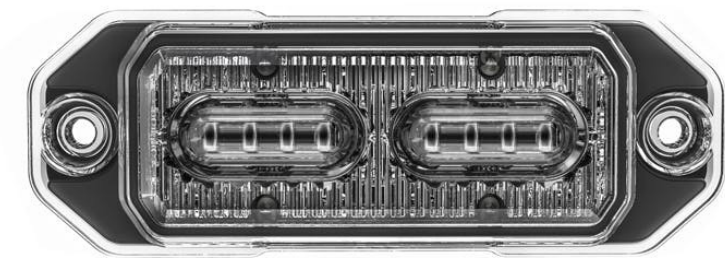

# STL MULTICOLOR Z-12 LINEAR

SKU G-LZMC12  
DIMENSIONS 5.7" L x 1.6" H x .6" D  
AVAILABLE COLORS 

- FEATURES**
- Eclipse Linear optics
  - 12 3-Watt LEDs
  - 34 warning flash patterns
  - Built-in sync capability
  - 3 alternate sync pattern speeds
  - Weatherproof housing



# STL MULTICOLOR ZX-180 LINEAR

SKU G-ZXLMC180  
DIMENSIONS 4.6" L x 1.6" H x 1.5" D  
AVAILABLE COLORS 

- FEATURES**
- Eclipse Linear optics
  - 8 3-Watt LEDs
  - 34 warning flash patterns
  - Built-in sync capability
  - 3 alternate sync pattern speeds
  - Weatherproof housing
  - Includes brackets for mounting



# STL HALF OCTO TIR

SKU G-HOT4

DIMENSIONS 7.4" L x 2.1" H x 2.25" D

AVAILABLE COLORS 

**FEATURES**

- Eclipse TIR optics
- 12 3-Watt LEDs
- 24 warning flash patterns
- Built-in sync capability
- 3 alternate sync pattern speeds
- Weatherproof housing

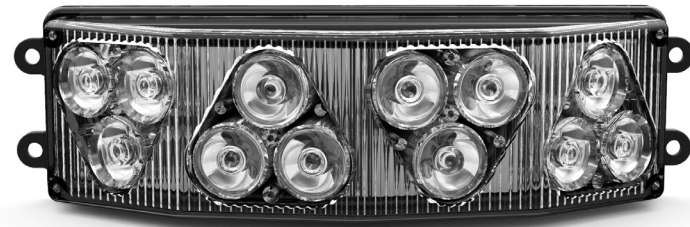

# STL ALPHA-Z 7X3 TIR

SKU G-A7X3

DIMENSIONS 7.6" L x 3.6"H x .6" D

AVAILABLE COLORS 

**FEATURES**

- Eclipse TIR optics
- 12 3-Watt LEDs
- 24 warning flash patterns
- Built-in sync capability
- 3 alternate sync pattern speeds
- Weatherproof housing

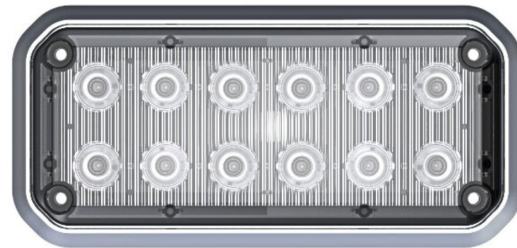

# STL ALPHA-Z 6X4 TIR

SKU G-A6X4

DIMENSIONS 7.1" L x 4.6"H x .6" D

AVAILABLE COLORS 

**FEATURES**

- Eclipse TIR optics
- 18 3-Watt LEDs
- 24 warning flash patterns
- Built-in sync capability
- 3 alternate sync pattern speeds
- Weatherproof housing

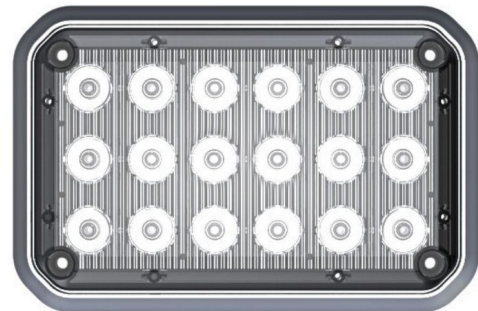

# STL ALPHA-Z 7X9 TIR

SKU G-A7X9

DIMENSIONS 9.25" L x 7.75"H x .6" D

AVAILABLE COLORS 

**FEATURES**

- Eclipse TIR optics
- 30 3-Watt LEDs
- 24 warning flash patterns
- Built-in sync capability
- 3 alternate sync pattern speeds
- Weatherproof housing

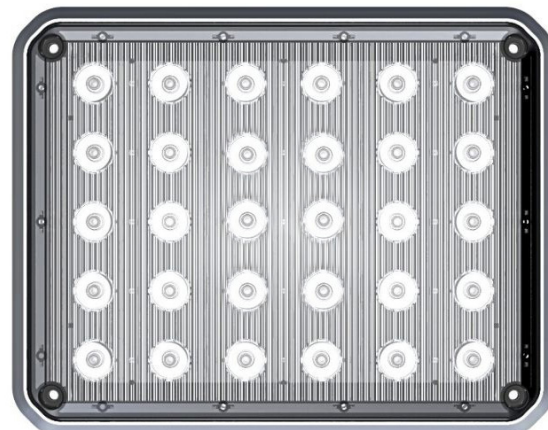

# STL FLARE-X

SKU K-FX1

DIMENSIONS 1.06" Base Diameter x 1" Height

AVAILABLE COLORS 

**FEATURES**

- Steady burn function
- 1 3-Watt LED
- Weatherproof housing



# STL FLARE-6 360°

SKU K-F6360

DIMENSIONS 1.6" Base Diameter x 1" Height

AVAILABLE COLORS 

**FEATURES**

- 6 optics in 360° configuration
- 6 3-Watt LEDs
- 32 warning flash patterns
- Built-in sync capability
- 3 alternate sync pattern speeds
- Weatherproof housing



# STL FLARE-12

SKU K-F12

DIMENSIONS 1.5" Base Diameter x .75" Height

AVAILABLE COLORS 

**FEATURES**

- 12 3-Watt LEDs
- 32 warning flash patterns
- Built-in sync capability
- 3 alternate sync pattern speeds
- Weatherproof housing





# STL CEPTOR-X TIR

SKU B-CTX4 / B-CTXSTD4

DIMENSIONS 60" L x 1.1" H x 2" D

AVAILABLE COLORS 

### FEATURES

- Eclipse TIR optics
- 48 3-Watt LEDs
- 26 warning flash patterns
- Built-in sync capability
- 3 alternate sync pattern speeds
- Weatherproof housing
- Optional STL Grand Control Switch Box (p. 36)



# STL CEPTOR TIR

SKU B-CT6 / B-CTSTD6

DIMENSIONS 60" L x 1.1" H x 2" D

AVAILABLE COLORS 

### FEATURES

- Eclipse TIR optics
- 72 3-Watt LEDs
- 26 warning flash patterns
- Built-in sync capability
- 3 alternate sync pattern speeds
- Weatherproof housing
- Optional STL Grand Control Switch Box (p. 36)

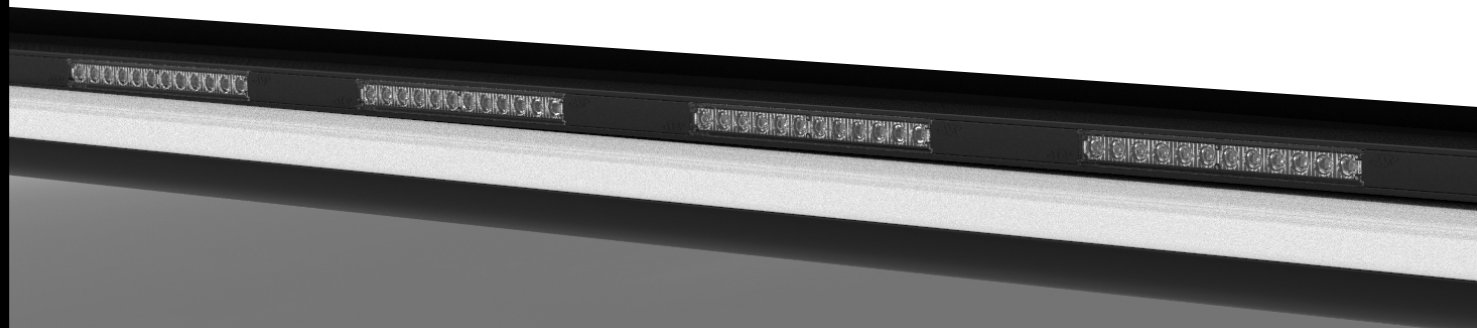

# STL OCTO TIR

SKU M-OT8

DIMENSIONS 6.5" Base Diameter x 3" Height

AVAILABLE COLORS 

### FEATURES

- Eclipse TIR optics
- 24 3-Watt LEDs
- 30 warning flash patterns with dual memory
- Weatherproof housing
- Includes magnetic base for mounting
- Optional Cigarette Plug with Control Switches (p. 38)



## STL K-FORCE MICRO 14 TIR

SKU M-TKFM14

**DIMENSIONS** 13.1" L x 3" H x 6.8" D

**AVAILABLE COLORS** 

### FEATURES

- Eclipse TIR optics
- 24 3-Watt LEDs
- 30 warning flash patterns with dual memory
- Weatherproof housing
- Includes magnetic feet for mounting
- Optional Cigarette Plug with Control Switches (p. 38)



## STL K-FORCE MICRO 21 TIR

SKU M-TKFM21

**DIMENSIONS** 22.1" L x 3" H x 6.8" D

**AVAILABLE COLORS** 

### FEATURES

- Eclipse TIR optics
- 40 3-Watt LEDs
- 30 warning flash patterns with dual memory
- Alley light functionality
- Weatherproof housing
- Includes magnetic feet for mounting
- Optional STL Grand Control Switch Box (p. 36)



## STL K-FORCE 18 TIR

SKU M-TKF18

**DIMENSIONS** 18.1" L x 2.9"H x 11.4" D

**AVAILABLE COLORS** 

### FEATURES

- Eclipse TIR optics
- 40 3-Watt LEDs
- 30 warning flash patterns with dual memory
- Weatherproof housing
- Includes magnetic feet for mounting
- Optional Cigarette Plug with Control Switches (p. 38)



## STL K-FORCE 27 TIR

SKU M-TKF27

**DIMENSIONS** 27.4" L x 2.9"H x 11.4" D

**AVAILABLE COLORS** 

### FEATURES

- Eclipse TIR optics
- 56 3-Watt LEDs
- 30 warning flash patterns with dual memory
- Alley light functionality
- Weatherproof housing
- Includes magnetic feet for mounting
- Optional STL Grand Control Switch Box (p. 36)



## STL MULTICOLOR K-FORCE MICRO 14 LINEAR

SKU M-LKFMMC14

**DIMENSIONS** 13.1" L x 3" H x 6.8" D

**AVAILABLE COLORS** 

### FEATURES

- Eclipse Linear optics
- 72 3-Watt LEDs
- 40 warning flash patterns with dual memory
- Weatherproof housing
- Includes magnetic feet for mounting
- Optional Cigarette Plug with Control Switches (p. 38)



## STL MULTICOLOR K-FORCE MICRO 21 LINEAR

SKU M-LKFMMC21

**DIMENSIONS** 22.1" L x 3" H x 6.8" D

**AVAILABLE COLORS** 

### FEATURES

- Eclipse Linear optics
- 120 3-Watt LEDs
- 40 warning flash patterns with dual memory
- Alley light functionality
- Weatherproof housing
- Includes magnetic feet for mounting
- Optional STL Grand Control Switch Box (p. 36)



## STL MULTICOLOR K-FORCE 18 LINEAR

SKU M-LKFMC18

**DIMENSIONS** 18.1" L x 2.9"H x 11.4" D

**AVAILABLE COLORS** 

### FEATURES

- Eclipse Linear optics
- 120 3-Watt LEDs
- 40 warning flash patterns with dual memory
- Weatherproof housing
- Includes magnetic feet for mounting
- Optional Cigarette Plug with Control Switches (p. 38)

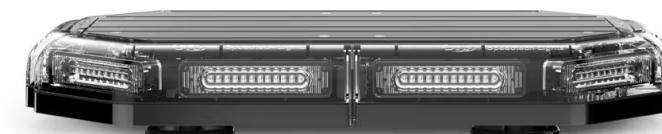

## STL MULTICOLOR K-FORCE 27 LINEAR

SKU M-LKFMC27

**DIMENSIONS** 27.4" L x 2.9"H x 11.4" D

**AVAILABLE COLORS** 

### FEATURES

- Eclipse Linear optics
- 168 3-Watt LEDs
- 40 warning flash patterns with dual memory
- Alley light functionality
- Weatherproof housing
- Includes magnetic feet for mounting
- Optional STL Grand Control Switch Box (p. 36)



## STL K-FORCE MICRO 50 TIR

SKU F-TKFM50

DIMENSIONS 49.1" L x 3.6"H x 5.5" D

AVAILABLE COLORS 

### FEATURES

- Eclipse TIR optics
- 88 3-Watt LEDs
- 30 warning flash patterns with dual memory
- 3 directional flash patterns
- Built-in rear amber traffic advisor
- Take down/alley/cruise mode functionality
- Weatherproof housing
- Includes support feet & gutter brackets for mounting
- Optional STL Supreme Control Switch Box (p. 36)



## STL K-FORCE 36 TIR

SKU F-TKF36

DIMENSIONS 36.6" L x 3.6"H x 11.4" D

AVAILABLE COLORS 

### FEATURES

- Eclipse TIR optics
- 72 3-Watt LEDs
- 30 warning flash patterns with dual memory
- 3 directional flash patterns
- Built-in rear amber traffic advisor
- Take down/alley/cruise mode functionality
- Weatherproof housing
- Includes support feet & gutter brackets for mounting
- Optional STL Supreme Control Switch Box (p. 36)



## STL K-FORCE 47 TIR

SKU F-TKF47 / F-TKFSTD47

DIMENSIONS 45.9" L x 3.6"H x 11.4" D

AVAILABLE COLORS 

### FEATURES

- Eclipse TIR optics
- 88 3-Watt LEDs
- 30 warning flash patterns with dual memory
- 3 directional flash patterns
- Built-in rear amber traffic advisor
- Take down/alley/cruise mode functionality
- Weatherproof housing
- Includes support feet & gutter brackets for mounting
- Optional STL Supreme Control Switch Box (p. 36)



OPTIONAL UPGRADE  
SUPER TAKE DOWN 

## STL K-FORCE 55 TIR

SKU F-TKF55

DIMENSIONS 55.1" L x 3.6"H x 11.4" D

AVAILABLE COLORS 

### FEATURES

- Eclipse TIR optics
- 104 3-Watt LEDs
- 30 warning flash patterns with dual memory
- 3 directional flash patterns
- Built-in rear amber traffic advisor
- Take down/alley/cruise mode functionality
- Weatherproof housing
- Includes support feet & gutter brackets for mounting
- Optional STL Supreme Control Switch Box (p. 36)



## STL MULTICOLOR K-FORCE MICRO 50 LINEAR

SKU F-LKFMMC50

DIMENSIONS 49.1" L x 3.6"H x 5.5" D

AVAILABLE COLORS 

### FEATURES

- Eclipse Linear optics
- 232 3-Watt LEDs
- 40 warning flash patterns with dual memory
- 3 directional flash patterns
- Built-in rear amber traffic advisor
- Take down/alley/cruise mode functionality
- Weatherproof housing
- Includes support feet & gutter brackets for mounting
- Optional STL Supreme Control Switch Box (p. 36)



## STL MULTICOLOR K-FORCE 36 LINEAR

SKU F-LKFMC36

DIMENSIONS 36.6" L x 3.6"H x 11.4" D

AVAILABLE COLORS 

### FEATURES

- Eclipse Linear optics
- 184 3-Watt LEDs
- 40 warning flash patterns with dual memory
- 3 directional flash patterns
- Built-in rear amber traffic advisor
- Take down/alley/cruise mode functionality
- Weatherproof housing
- Includes support feet & gutter brackets for mounting
- Optional STL Supreme Control Switch Box (p. 36)



## STL MULTICOLOR K-FORCE 47 LINEAR

SKU F-LKFMC47

DIMENSIONS 45.9" L x 3.6"H x 11.4" D

AVAILABLE COLORS 

### FEATURES

- Eclipse Linear optics
- 232 3-Watt LEDs
- 40 warning flash patterns with dual memory
- 3 directional flash patterns
- Built-in rear amber traffic advisor
- Take down/alley/cruise mode functionality
- Weatherproof housing
- Includes support feet & gutter brackets for mounting
- Optional STL Supreme Control Switch Box (p. 36)



## STL MULTICOLOR K-FORCE 55 LINEAR

SKU F-LKFMC55

DIMENSIONS 55.1" L x 3.6"H x 11.4" D

AVAILABLE COLORS 

### FEATURES

- Eclipse Linear optics
- 280 3-Watt LEDs
- 40 warning flash patterns with dual memory
- 3 directional flash patterns
- Built-in rear amber traffic advisor
- Take down/alley/cruise mode functionality
- Weatherproof housing
- Includes support feet & gutter brackets for mounting
- Optional STL Supreme Control Switch Box (p. 36)



## STL K-FORCE 65 TIR

SKU F-TKF63

**DIMENSIONS** 64.4" L x 3.6"H x 11.4" D

**AVAILABLE COLORS** 

### FEATURES

- Eclipse TIR optics
- 120 3-Watt LEDs
- 30 warning flash patterns with dual memory
- 3 directional flash patterns
- Built-in rear amber traffic advisor
- Take down/alley/cruise mode functionality
- Weatherproof housing
- Includes support feet & gutter brackets for mounting
- Optional STL Supreme Control Switch Box (p. 36)



## STL K-FORCE 75 TIR

SKU F-TKF71

**DIMENSIONS** 73.6" L x 3.6"H x 11.4" D

**AVAILABLE COLORS** 

### FEATURES

- Eclipse TIR optics
- 136 3-Watt LEDs
- 30 warning flash patterns with dual memory
- 3 directional flash patterns
- Built-in rear amber traffic advisor
- Take down/alley/cruise mode functionality
- Weatherproof housing
- Includes support feet & gutter brackets for mounting
- Optional STL Supreme Control Switch Box (p. 36)



## STL K-FORCE MICRO 50 TIR Tow

SKU F-TKFMTO50

**DIMENSIONS** 49.1" L x 3.6"H x 5.5" D

**AVAILABLE COLORS** 

### FEATURES

- Eclipse TIR optics
- 88 3-Watt LEDs
- 30 warning flash patterns with dual memory
- 3 directional flash patterns
- Built-in rear amber traffic advisor
- Take down/alley/rear work light/cruise mode functionality
- Stop/Tail/Turn light functionality
- Weatherproof housing
- Includes support feet & gutter brackets for mounting
- Optional STL Supreme Control Switch Box (p. 36)



## STL K-FORCE 55 TIR Tow

SKU F-TKFTOW55

**DIMENSIONS** 55.1" L x 3.6"H x 11.4" D

**AVAILABLE COLORS** 

### FEATURES

- Eclipse TIR optics
- 104 3-Watt LEDs
- 30 warning flash patterns with dual memory
- 3 directional flash patterns
- Built-in rear amber traffic advisor
- Take down/alley/rear work light/cruise mode functionality
- Stop/Tail/Turn light functionality
- Weatherproof housing
- Includes support feet & gutter brackets for mounting
- Optional STL Supreme Control Switch Box (p. 36)



## STL K-FORCE 65 TIR Tow

SKU F-TKFTOW63

**DIMENSIONS** 64.4" L x 3.6"H x 11.4" D

**AVAILABLE COLORS** 

### FEATURES

- Eclipse TIR optics
- 120 3-Watt LEDs
- 30 warning flash patterns with dual memory
- 3 directional flash patterns
- Built-in rear amber traffic advisor
- Take down/alley/rear work light/cruise mode functionality
- Stop/Tail/Turn light functionality
- Weatherproof housing
- Includes support feet & gutter brackets for mounting
- Optional STL Supreme Control Switch Box (p. 36)



# STL CARBINE 10"

SKU W-C10F / W-C10H  
DIMENSIONS 10" L x 2" H x 2.2" D  
AVAILABLE COLORS

- FEATURES**
- Steady burn function
  - 9 3-Watt LEDs
  - 3,780 Lumens
  - Weatherproof housing
  - Includes adjustable L-shape end cap brackets



# STL CARBINE 20"

SKU W-C20F / W-C20H  
DIMENSIONS 20.8" L x 2" H x 2.2" D  
AVAILABLE COLORS

- FEATURES**
- Steady burn function
  - 21 3-Watt LEDs
  - 8,820 Lumens
  - Weatherproof housing
  - Includes adjustable L-shape end cap brackets



# STL CARBINE 40"

SKU W-C40F / W-C40H  
DIMENSIONS 39.5" L x 2" H x 2.2" D  
AVAILABLE COLORS

- FEATURES**
- Steady burn function
  - 42 3-Watt LEDs
  - 17,640 Lumens
  - Weatherproof housing
  - Includes adjustable L-shape end cap brackets



# STL DUAL CARBINE 7"

SKU W-DC7F / W-DC7H  
DIMENSIONS 8" L x 3.5" H x 2.2" D  
AVAILABLE COLORS

- FEATURES**
- Steady burn function
  - 12 1.5-Watt LEDs
  - 2,280 Lumens
  - Weatherproof housing
  - Includes adjustable L-shape end cap brackets



# STL DUAL CARBINE 13"

SKU W-DC13F / W-DC13H  
DIMENSIONS 14" L x 3.5" H x 2.2" D  
AVAILABLE COLORS

- FEATURES**
- Steady burn function
  - 24 1.5-Watt LEDs
  - 4,560 Lumens
  - Weatherproof housing
  - Includes adjustable L-shape end cap brackets



# STL DUAL CARBINE 20"

SKU W-DC20F / W-DC20H  
DIMENSIONS 22" L x 3.5" H x 2.2" D  
AVAILABLE COLORS

- FEATURES**
- Steady burn function
  - 40 1.5-Watt LEDs
  - 7,600 Lumens
  - Weatherproof housing
  - Includes adjustable L-shape end cap brackets



# STL DUAL CARBINE 30"

SKU W-DC30F / W-DC30H  
DIMENSIONS 32" L x 3.5" H x 2.2" D  
AVAILABLE COLORS

- FEATURES**
- Steady burn function
  - 60 1.5-Watt LEDs
  - 11,880 Lumens
  - Weatherproof housing
  - Includes adjustable L-shape end cap brackets



# STL DUAL CARBINE 50"

SKU W-DC50F / W-DC50H  
DIMENSIONS 50" L x 3.5" H x 2.2" D  
AVAILABLE COLORS

- FEATURES**
- Steady burn function
  - 96 1.5-Watt LEDs
  - 18,240 Lumens
  - Weatherproof housing
  - Includes adjustable L-shape end cap brackets



# STL QUAD CARBINE

SKU W-QC9F / W-QC9H

DIMENSIONS 3.75" L x 4.3" H x 2.25" D

AVAILABLE COLORS

### FEATURES

- Steady burn function
- 9 3-Watt LEDs
- 1,980 Lumens
- Weatherproof housing
- Includes adjustable mounting bracket



AVAILABLE CARBINE OPTICS  
FLOODLIGHT

# STL QUAD CARBINE-16

SKU W-QC16F / W-QC16S

DIMENSIONS 4.25" L x 5" H x 1.6" D

AVAILABLE COLORS

### FEATURES

- Steady burn function
- 16 1.5-Watt LEDs
- 3,040 Lumens
- Weatherproof housing
- Includes adjustable mounting bracket



AVAILABLE CARBINE OPTICS  
FLOODLIGHT

# STL QUAD CARBINE-18

SKU W-QCF18

DIMENSIONS 3.8" L x 4" H x 1.75" D

AVAILABLE COLORS

### FEATURES

- Steady burn & warning functions
- 18 total LEDs:
  - ◊ 9 1-Watt warning LEDs (in amber color)
  - ◊ 9 5-Watt steady burn LEDs (in clear color)
- 3,984 Lumens
- Weatherproof housing
- Includes adjustable mounting bracket



AVAILABLE CARBINE OPTICS  
FLOODLIGHT

# STL CARBINE 140°

SKU W-C140CC

DIMENSIONS 3.6" L x 3" H x 2.75" D

AVAILABLE COLORS

### FEATURES

- Steady burn function
- 15 1.5-Watt LEDs
- 2,850 Lumens
- Weatherproof housing
- Includes adjustable mounting bracket



AVAILABLE CARBINE OPTICS  
SPOTLIGHT

# STL CIRCLE CARBINE

SKU W-CC7F / W-CC7H

DIMENSIONS 3.8" L x 4.6" H x 2.3" D

AVAILABLE COLORS

### FEATURES

- Steady burn function
- 7 3-Watt LEDs
- 1,540 Lumens
- Weatherproof housing
- Includes adjustable mounting bracket



AVAILABLE CARBINE OPTICS  
FLOODLIGHT

# STL CIRCLE CARBINE-14

SKU W-CC14F / W-CC14H

DIMENSIONS 6.4" L x 7.2" H x 1.7" D

AVAILABLE COLORS

### FEATURES

- Steady burn function
- 14 3-Watt LEDs
- 3,080 Lumens
- Steady burn function
- Weatherproof housing
- Includes adjustable mounting bracket



AVAILABLE CARBINE OPTICS  
FLOODLIGHT

# STL CIRCLE CARBINE-18

SKU W-CCF18

DIMENSIONS 4.25" L x 4.25" H x 1.75" D

AVAILABLE COLORS

### FEATURES

- Steady burn & warning functions
- 18 total LEDs:
  - ◊ 9 1-Watt warning LEDs (in amber color)
  - ◊ 9 5-Watt steady burn LEDs (in clear color)
- 4,054 Lumens
- Weatherproof housing
- Includes adjustable mounting bracket



AVAILABLE CARBINE OPTICS  
FLOODLIGHT

# STL CARBINE 140° WARNING

SKU W-C140

DIMENSIONS 3.6" L x 3" H x 2.75" D

AVAILABLE COLORS

### FEATURES

- Steady burn & warning functions
- 10 total LEDs:
  - ◊ 6 1.5-Watt side warning LEDs (in select color)
  - ◊ 4 3-Watt center steady burn LEDs (in clear color)
- 2,750 Lumens
- Weatherproof housing
- Includes adjustable mounting bracket

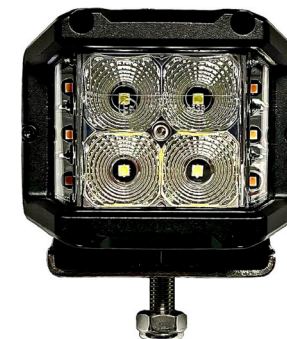

AVAILABLE CARBINE OPTICS  
FLOODLIGHT

# STL DUAL CARBINE 14" WARNING

SKU W-DCC14

DIMENSIONS 14.75" L x 4" H x 3.25" D

AVAILABLE COLORS

### FEATURES

- Steady burn & warning functions
- 24 total 1.5-Watt LEDs:
  - ◊ 12 side warning LEDs (in select color)
  - ◊ 12 center steady burn LEDs (in clear color)
- 2,280 Lumens (for center steady burn modules)
- 24 warning flash patterns
- Weatherproof housing
- Includes adjustable L-shape end cap brackets



AVAILABLE CARBINE OPTICS  
SPOTLIGHT

# STL DUAL CARBINE 20" WARNING

SKU W-DCC20

DIMENSIONS 20.75" L x 4" H x 3.25" D

AVAILABLE COLORS

### FEATURES

- Steady burn & warning functions
- 36 total 1.5-Watt LEDs:
  - ◊ 12 side warning LEDs (in select color)
  - ◊ 24 center steady burn LEDs (in clear color)
- 4,560 Lumens (for center steady burn modules)
- 24 warning flash patterns
- Weatherproof housing
- Includes adjustable L-shape end cap brackets



AVAILABLE CARBINE OPTICS  
SPOTLIGHT

# STL CUBE CARBINE FLUSH MOUNT

SKU W-CUCFF

DIMENSIONS 4.8" L x 3.6" H x 3.1" D

AVAILABLE COLORS

### FEATURES

- Steady burn function
- 6 3-Watt LEDs
- 1,620 Lumens
- Weatherproof housing



AVAILABLE CARBINE OPTICS  
FLOODLIGHT

# STL CIRCLE CARBINE FLUSH MOUNT

SKU W-CCFF

DIMENSIONS 4.7" L x 4.7" H x 2.1" D

AVAILABLE COLORS

### FEATURES

- Steady burn function
- 6 3-Watt LEDs
- 1,620 Lumens
- Weatherproof housing



AVAILABLE CARBINE OPTICS  
FLOODLIGHT

# STL Hex CARBINE FLUSH MOUNT

SKU W-HCFF

DIMENSIONS 6.2" L x 3.3" H x 1.1" D

AVAILABLE COLORS

### FEATURES

- Steady burn function
- 6 3-Watt LEDs
- 1,620 Lumens
- Weatherproof housing



AVAILABLE CARBINE OPTICS  
FLOODLIGHT

# STL CARBINE-Z FLUSH MOUNT

SKU W-CZFF

DIMENSIONS 7.6" L x 2.4" H x 1.8" D

AVAILABLE COLORS

### FEATURES

- Steady burn function
- 6 3-Watt LEDs
- 1,620 Lumens
- Weatherproof housing



AVAILABLE CARBINE OPTICS  
FLOODLIGHT

# STL CARBINE ANGLE SURFACE MOUNT

SKU W-CASM

DIMENSIONS 5.9" L x 1.85" H x 1.6" D

AVAILABLE COLORS

### FEATURES

- Steady burn function
- 52 1-Watt LEDs
- 2,296 Lumens
- Weatherproof housing

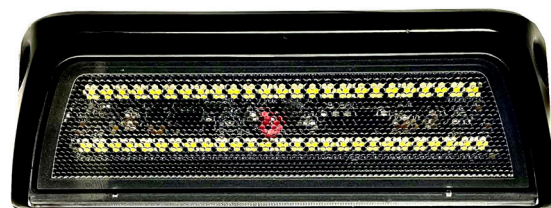

# STL CARBINE-X MINI

SKU W-CXMF

DIMENSIONS 2.1" L x 2.1" H x 1.25" D

AVAILABLE COLORS

### FEATURES

- Steady burn function
- 8 1.5-Watt LEDs
- 1,200 Lumens
- Weatherproof housing
- Includes adjustable mounting bracket



AVAILABLE CARBINE OPTICS  
FLOODLIGHT

# STL MICRO CARBINE

SKU W-MC3

DIMENSIONS 3" L x 1.75" H x .8" D

AVAILABLE COLORS

### FEATURES

- Steady burn function
- 3 3-Watt / 5-Watt LEDs (Watts based on color)
- 810 / 1,260 Lumens (Lumens based on color)
- Weatherproof housing
- Includes flat & curved rubber bases for mounting



# STL CARBINE 12V RELAY

SKU P-12RELAY

### FEATURES

- 12V relay harness
- 1 on/off switch rated for 60 amps
- Compatible with STL Carbine Series
- Optional Wireless Remote features flashing capability



# STL CARBINE SERIES LENS COVER

AVAILABLE COLORS

### FEATURES

- Colored lens cover
- Snaps over front of unit
- Available models:
  - ◊ P-CLENS: for STL Circle Carbine
  - ◊ P-QCLENS: for STL Quad Carbine
  - ◊ P-DCLENS: for STL Dual Carbine Series



# STL TAILGATE 48" WARNING

SKU T-TGW48

DIMENSIONS 47.6" L x 1" H x .25" D

AVAILABLE COLORS

### FEATURES

- Steady burn & warning functions
- 480 LEDs
- 29 warning flash patterns
- Dual row tailgate bar with independent controls:
  - ◊ Top row - warning mode (in select color)
  - ◊ Bottom row - reverse/steady burn mode (in clear color)
- Weatherproof housing
- Includes double-sided tape for mounting



# STL TAILGATE 60" WARNING

SKU T-TGW60

DIMENSIONS 59.5" L x 1" H x .25" D

AVAILABLE COLORS

### FEATURES

- Steady burn & warning functions
- 624 LEDs
- 29 warning flash patterns
- Dual row tailgate bar with independent controls:
  - ◊ Top row - warning mode (in select color)
  - ◊ Bottom row - reverse/steady burn mode (in clear color)
- Weatherproof housing
- Includes double-sided tape for mounting





# STL FURY

SKU S-FMS30

DIMENSIONS 5" L x 5.25" H x 5.5" D

## FEATURES

- 30-Watt amplifier/speaker output
- Combined all-in-one siren & speaker unit
- Clear sound frequency
- Warning tone function
- Tones include:
  - ◊ Siren: Wail, Yelp, Sting, Mech, Tool, Hi-Lo
  - ◊ Horn: High, Low
- Weatherproof housing
- Includes L-bracket for mounting unit
- Optional STL Moto-4 Switch Box (p. 38)



# STL VIREO

SKU S-VR100

CONTROLLER DIMENSIONS 2.5" L x 4.9" H x .8" D

AMPLIFIER DIMENSIONS 8.5" L x 2.75" H x 5.75" D

## FEATURES

- 100-Watt amplifier output
- PA & warning tone functions
- Tones include:
  - ◊ Siren: Wail, Yelp, Sting, Mech, Tool, Hi-Lo
  - ◊ Horn: High, Low
- Programmable manual mode
- Radio rebroadcast function
- 6 auxiliary switches rated for 10 amps each
- Handheld controller with built in microphone



# STL PA

SKU S-HPA100

DIMENSIONS 5.5" L x 1.75" H x 3.25" D

## FEATURES

- 100-Watt amplifier output
- Combined amplifier & controller unit
- PA & horn tone functions
- Horn tones include: High, Low
- Includes microphone



# STL APEX

SKU S-AP100

CONTROLLER DIMENSIONS 5.75" L x 3.25" H x 1.4" D

AMPLIFIER DIMENSIONS 8.5" L x 2.75" H x 5.75" D

## FEATURES

- 100-Watt amplifier output
- PA & warning tone functions
- Tones include:
  - ◊ Siren: Wail, Yelp, Sting, Mech, Tool, Hi-Lo
  - ◊ Horn: High, Low
- Programmable manual mode
- Radio rebroadcast function
- 6 auxiliary switches rated for 10 amps each
- Includes microphone



# STL MEGA

SKU S-MG100

DIMENSIONS 5.5" L x 1.75" H x 3.25" D

## FEATURES

- 100-Watt amplifier output
- Combined amplifier & controller unit
- PA & warning tone functions
- Tones include:
  - ◊ Siren: Wail, Yelp, Sting, Mech, Tool, Hi-Lo
  - ◊ Horn: High, Low
- Includes microphone



# STL BOSS

SKU S-BDT200

CONTROLLER DIMENSIONS 5.4" L x 2.5" H x 1.5" D

AMPLIFIER DIMENSIONS 8.5" L x 2.75" H x 5.75" D

## FEATURES

- 200-Watt amplifier output (for 2 100-Watt speakers)
- PA & warning tone functions
- Tones include:
  - ◊ Siren: Wail, Yelp, Sting, Mech, Tool, Hi-Lo
  - ◊ Horn: High, Low
- Programmable manual mode
- Radio rebroadcast function
- 6 auxiliary switches rated for 10 amps each
- Functions as 200-Watt 'Dual Tone' siren with 2 speakers (or as 100-Watt single tone siren with 1 speaker)
- 'Dual Tone' function enables independent siren tones to output from each speaker
- Includes microphone



## STL ICON SILVER 100-WATT SPEAKER

SKU A-IS100

DIMENSIONS 6.4" L x 6.9" H x 2.25" D

### FEATURES

- 100-Watt speaker output
- Clear sound frequency
- Compact design
- Silver finish
- Weatherproof housing
- Includes rotating bracket for mounting



## STL ICON BLACK 100-WATT SPEAKER

SKU A-IB100

DIMENSIONS 6.4" L x 6.9" H x 2.25" D

### FEATURES

- 100-Watt speaker output
- Clear sound frequency
- Compact design
- Black finish
- Weatherproof housing
- Includes rotating bracket for mounting



## STL 100-WATT CONE SPEAKER

SKU A-C100

DIMENSIONS 6.4" L x 4.6" H x 7.4" D

### FEATURES

- 100-Watt speaker output
- Clear sound frequency
- Weatherproof housing
- Includes flat bracket for mounting



## STL VIBE LOW FREQUENCY

SKU S-VLF

SPEAKER DIMENSIONS 8" Length x 7" Diameter

AMPLIFIER DIMENSIONS 5.25" L x 1.5" H x 6.3" D

### FEATURES

- 100-Watt speaker output
- 100-Watt amplifier output
- Low sound frequency generates tactile vibrations
- Weatherproof housing
- Includes bracket for mounting



WWW.SPEEDTECHLIGHTS.COM

## STL 3 PACK 15-LED ROAD FLARES

SKU BL-2000C-3P

DIMENSIONS PER ROAD FLARE UNIT 4.3" Diameter x 1.3" Height

AVAILABLE COLORS ■

### FEATURES

- Red LED Road Flares
- 15 LEDs per Road Flare unit:
  - ◊ 12 Red LEDs for warning mode
  - ◊ 3 Clear LEDs for steady burn on top
- 8 warning flash patterns
- Includes AAA Batteries
- Waterproof, floatable, & durable
- Magnetic base for mounting
- Power & flash pattern controls located on Road Flare units



## STL 6 PACK 16-LED RECHARGEABLE ROAD FLARES

SKU BL-2000R-6P

DIMENSIONS PER ROAD FLARE UNIT 4.25" Diameter x 1.5" Height

AVAILABLE COLORS ■

### FEATURES

- Rechargeable Red LED Road Flares
- 16 LEDs per Road Flare unit
- 9 warning flash patterns
- Includes carrying case/charger
- Carrying case charges all 6 Road Flare units together
- Waterproof, floatable, & durable
- Magnetic base for mounting
- Power & flash pattern controls located on Road Flare units



WWW.SPEEDTECHLIGHTS.COM

# STL GRAND CONTROL

SKU C-GCB / C-GCBSTD  
 DIMENSIONS 4.5" L x 2.5" H x 1.125" D  
 FEATURES

- Compatible with STL products
- Dual memory via mode buttons
- Power & flash pattern control
- Take down control
- Auxiliary switch rated for 10 amps
- Night mode via night button or cable hardwire
- Offered in 2 variants:
  - ◊ C-GCB: No modifications (standard model)
  - ◊ C-GCBSTD: Auxiliary switch replaced by Super Take Down



# STL DIRECT CONTROL

SKU C-DCB  
 DIMENSIONS 4.75" L x 2.625" H x 1.125" D  
 FEATURES

- Compatible with STL products
- Dual memory via mode buttons
- Power & flash pattern control
- Directional pattern control
- 2-position flash pattern speed control
- Auxiliary switch rated for 10 amps
- Night mode via night button or cable hardwire



# STL GRANDIRECT CONTROL

SKU C-GDCB / C-GDCBSTD  
 DIMENSIONS 6.375" L x 2.875" H x 1.25" D  
 FEATURES

- Compatible with STL products
- Combination of Grand & Direct Control
- Dual memory via mode buttons
- 2 independent power & flash pattern controls
- Directional pattern control
- Take down control
- 2-position flash pattern speed control
- 2 auxiliary switches rated for 10 amps each
- Night mode via night button or cable hardwire
- Offered in 2 variants:
  - ◊ C-GDCB: No modifications (standard model)
  - ◊ C-GDCBSTD: Auxiliary switch (on left side) replaced by Super Take Down



# STL SUPREME CONTROL

SKU C-SPRCB / C-SPRCBSTD  
 DIMENSIONS 6.5" L x 3.25" H x 1.125" D  
 FEATURES

- Compatible with STL products
- Dual memory via mode button
- 3-stage power control
- Flash pattern control
- Directional pattern control
- Take down, alley, & cruise controls
- Auxiliary switch rated for 10 amps
- Night mode via night button or cable hardwire
- Offered in 2 variants:
  - ◊ C-SPRCB: No modifications (standard model)
  - ◊ C-SPRCBSTD: Auxiliary switch replaced by Super Take Down



# NIGHT MODE

**Night Mode is a feature on select control boxes that offers backlighting for the buttons on the control box. It can be easily activated either by pressing the 'NIGHT' button or by using the white cable to hardwire and automate this feature.**

**1. Using the 'NIGHT' Button:**

- Toggle the Night Mode on or off with the button labeled 'NIGHT'.
- This option is only available when the white cable is not hardwired.

**2. Using the White Cable:**

- Hardwire the standalone white cable to your headlight's +12VDC line to automate the Night Mode feature.
- Important: Once the white cable is hardwired, the 'NIGHT' button will no longer function.
- Ensure that the 'NIGHT' button is deactivated (not illuminated) before wiring the white cable. If the 'NIGHT' button is active during wiring, it will stay permanently illuminated.



## STL CIGARETTE PLUG WITH SWITCHES

SKU C-CLP

DIMENSIONS 1.5" L x 1.1" H x 3.75" D

### FEATURES

- Compatible with STL & 3rd party units
- Rated for 10 amps
- 3-position on/off/on switch for toggling 2 power modes
- Momentary switch for flash pattern cycle



## STL 3 SOCKET CIGARETTE PLUG SPLITTER

SKU C-3SCPS

DIMENSIONS 3.5" L x 1.3" H x 3" D

### FEATURES

- Compatible with STL & 3rd party units
- 3 cigarette plug splitter
- 10 amps capacity per plug
- LED on/off indicator



## STL Moto-4 Switch Box

SKU C-MCB

DIMENSIONS 2.3" L x 2.75" H x 2.3" D

### FEATURES

- Compatible with STL Fury Siren
- 4 switches (+1 master POWER switch to enable 4 switches):
  - ◊ 1 on/off toggle switch for auxiliary warning light or siren tone (A)
  - ◊ 1 manual mode momentary switch for air horn or siren tone (B)
  - ◊ 2 on/off toggle switches for siren tones only (C/D)
- LED backlit buttons
- Weatherproof housing
- Includes handlebar mount & flat mount



## STL WIRELESS REMOTE SWITCH BOX

SKU C-RSB

REMOTE CONTROLLER DIMENSIONS 1.5" L x 3.25" H x .5" D

POWER SUPPLY DIMENSIONS 3.75" L x 1" H x 2.25" D

### FEATURES

- Compatible with STL & 3rd party units
- 6 switches rated for 10 amps each
- Allows for on/off or flash pattern control
- Allows for master power control
- Range of up to 100 feet
- Includes 1 remote key fob controller



## STL 3 SWITCH BOX

SKU C-3SCB

DIMENSIONS 5.2" L x 1.6" H x 2.75" D

### FEATURES

- Compatible with STL & 3rd party units
- 3 switches rated for 15 amps each:
  - ◊ 2 on/off toggle switches (A/B)
  - ◊ 1 momentary switch (C)
- LED backlit buttons with night mode input
- Includes U-shape bracket for mounting

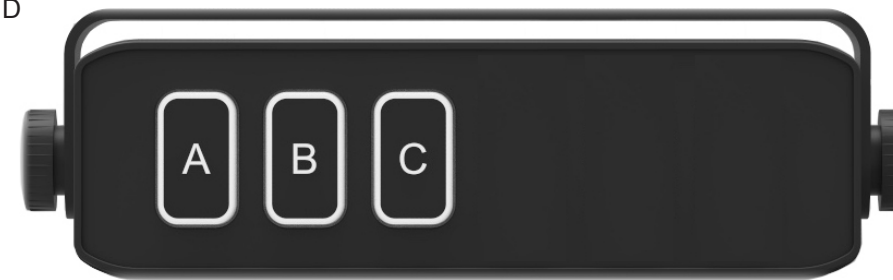

## STL 4 SWITCH BOX

SKU C-4SCB

DIMENSIONS 5.2" L x 1.6" H x 2.75" D

### FEATURES

- Compatible with STL & 3rd party units
- 4 switches rated for 15 amps each:
  - ◊ 3 on/off toggle switches (A/B/C)
  - ◊ 1 momentary switch (D)
- LED backlit buttons with night mode input
- Includes U-shape bracket for mounting

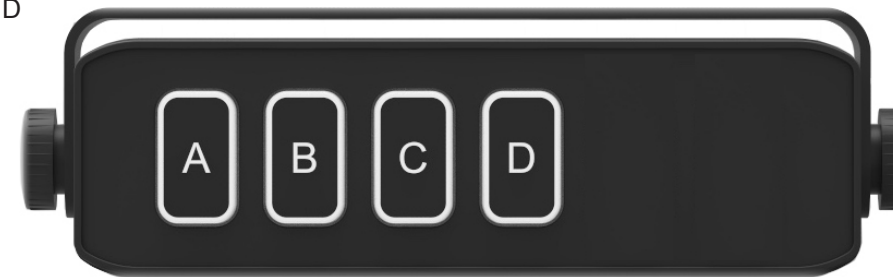

## STL 5 SWITCH BOX

SKU C-5SCB

DIMENSIONS 5.2" L x 1.6" H x 2.75" D

### FEATURES

- Compatible with STL & 3rd party units
- 5 switches rated for 15 amps each:
  - ◊ 4 on/off toggle switches (A/B/C/D)
  - ◊ 1 momentary switch (E)
- LED backlit buttons with night mode input
- Includes U-shape bracket for mounting

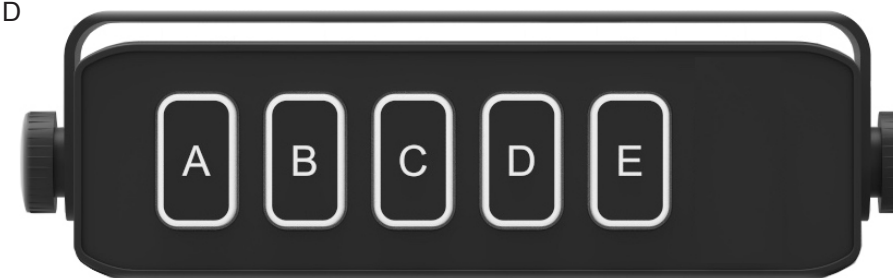

## STL 6 SWITCH BOX

SKU C-6SCB

DIMENSIONS 5.2" L x 1.6" H x 2.75" D

### FEATURES

- Compatible with STL & 3rd party units
- 6 switches rated for 15 amps each:
  - ◊ 5 on/off toggle switches (A/B/C/D/E)
  - ◊ 1 momentary switch (F)
- LED backlit buttons with night mode input
- Includes U-shape bracket for mounting

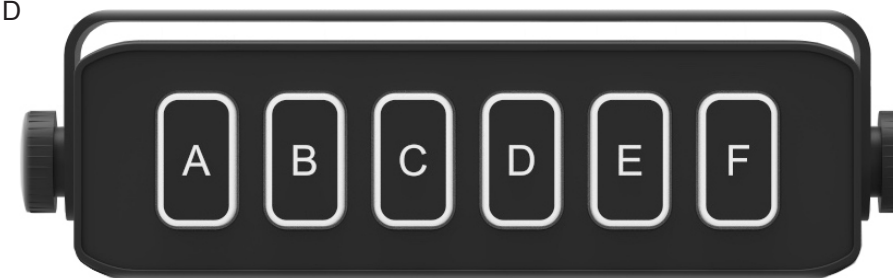

## STL RETRACTABLE FOCUS-BEAM

SKU J-RFB80

**DIMENSIONS** 4.4" Extended (4.1" Retracted) Length x 1.15" Lamp (1" Handle) Diameter

**AVAILABLE COLORS**

### FEATURES

- High power LED
- 80 Lumens
- Adjustable Focus
- On/off push button also toggles modes
- Modes: High, Low, Strobe
- Water resistant: IP44
- Shockproof: Up to 3 feet
- Weight: 2.7 ounces
- Includes 1 AA battery



## STL FOCAL-BEAM

SKU J-FB700

**DIMENSIONS** 5" Length x 1.25" Lamp (1" Handle) Diameter

**AVAILABLE COLORS**

### FEATURES

- High power LED
- 700 Lumens
- On/off push button also toggles modes
- Modes: High, Low, Strobe, SOS (hold button for SOS)
- Water resistant: IP44
- Shockproof: Up to 3 feet
- Weight: 4 ounces
- Battery life: High mode -> 2 hours, Low mode -> 7 hours
- Includes rechargeable Li-ion 18650 battery
- Includes micro USB charger with charge status indicator



## STL ALTER-BEAM

SKU J-AB800

**DIMENSIONS** 8.5" Full (6" Adjusted) Length x 1.5" Lamp (1" Handle) Diameter

**AVAILABLE COLORS**

### FEATURES

- High power LED
- 800 Lumens
- Adjustable: Full 8.5" length or Adjusted 6" length
- On/off push button also toggles modes
- Modes: High, Medium, Low, Strobe, SOS
- Waterproof: IP68
- Shockproof: Up to 5 feet
- Weight: Full length -> 6.5 ounces, Adjusted length -> 5.3 ounces
- Full length battery life: High -> 3 hours, Medium -> 12 hours, Low -> 100 hours
- Adjusted length battery life: High -> 1.5 hours, Medium -> 6 hours, Low -> 50 hours
- Uses 123A batteries: 4 batteries in Full length, 2 batteries in Adjusted length (batteries sold separately)



## STL FULL LIGHT BAR BRACKETS

SKU Q-LB\_

### FEATURES

- Vehicle specific mounting brackets for STL Full Light Bars
- Set includes pair of brackets
- See website for available vehicle models

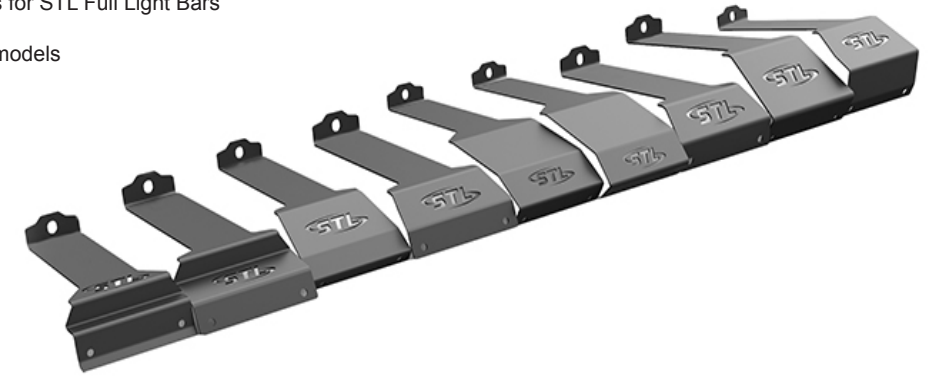

## STL RAPTOR SERIES VISOR BRACKETS

SKU Q-RV\_

### FEATURES

- Vehicle specific mounting brackets for STL Raptor Series
- See website for available vehicle models



## STL RAPTOR WINDSHIELD VISOR EXTENDER

SKU Q-RVE

### FEATURES

- Compatible with STL Raptor Series
- Mitigates light from reflecting internally off windshield
- Includes both driver and passenger side extenders



## STL 90° SUCTION CUP BRACKET

SKU Q-90SC

### FEATURES

- Adjustable suction cup bracket
- 90° windshield mount capability
- Set includes bracket with 3 rubber suction cups

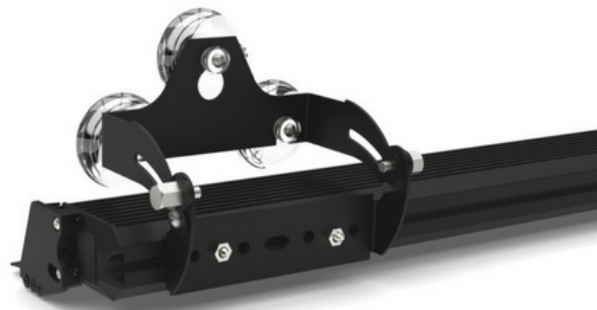

## STL 360° SUCTION CUP & L BRACKETS

SKU Q-360B

### FEATURES

- Suction cup & L-shape bracket in one
- 360° windshield or dash mount capability
- Set includes pair of brackets with 4 rubber suction cups

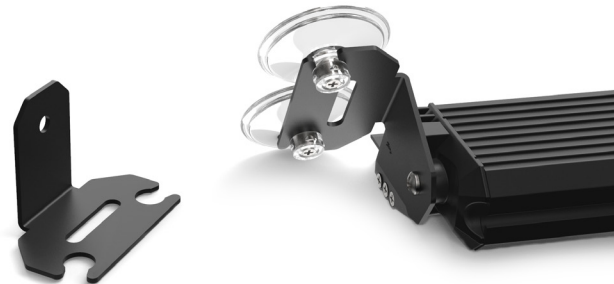

## STL SURFACE MOUNT END CAPS

SKU Q-SMEC

### FEATURES

- Surface mount brackets
- Compatible with STL Striker & Virtue Series
- Set includes pair of end cap brackets



## STL STRIKER/VIRTUE SERIES WINDSHIELD VISOR

SKU Q-SV\_VISOR

### FEATURES

- Compatible with STL Striker & Virtue Series
- Mitigates light from reflecting internally off windshield
- Available models:
  - ◊ Q-SV1VISOR
  - ◊ Q-SV2VISOR
  - ◊ Q-SV4VISOR
  - ◊ Q-SV6VISOR
  - ◊ Q-SV8VISOR



## STL PERMANENT STUD MOUNT LIGHT BAR BRACKET

SKU Q-LBPM

### FEATURES

- Stud mount bracket
- Perfect for mounting STL Mini & Full Light Bars



## STL HEADACHE RACK LIGHT BAR BRACKET

SKU Q-LBHRMB

### FEATURES

- Headache rack bracket
- Perfect for mounting STL Mini & Full Light Bars



## STL CARBINE SERIES LOWER WINDSHIELD BRACKETS FOR JEEP WRANGLER JK

SKU Q-JEEPLW2P

### FEATURES

- Jeep Wrangler JK lower windshield mounting brackets
- Compatible with STL Carbine Series units that include stud mounts
- Set includes pair of brackets



## STL CARBINE SERIES 50" LIGHT BAR BRACKETS

### FEATURES

- Compatible with STL Carbine Series 50" units
- Set includes pair of brackets
- See website for available vehicle models



## STL STATIC HEADLINER BRACKET

SKU Q-STHB

DIMENSIONS 4.75" L x 1.75" H x 7" D

### FEATURES

- L-shape bracket
- Attaches to headliner of vehicle
- Perfect for mounting dash lights, grille lights, or individual LED units



## STL ADJUSTABLE HEADLINER BRACKET

SKU Q-ADHB

DIMENSIONS 3.5" L x 1.75" H x 7.5" D

### FEATURES

- Adjustable L-shape bracket
- Attaches to headliner of vehicle
- Perfect for mounting dash lights, grille lights, or individual LED units



## STL SINGLE STATIC BRACKET

SKU Q-SSTB

DIMENSIONS 5" L x 1.25" H x 1.25" D

### FEATURES

- L-shape bracket
- Compatible with STL Z Series



## STL DUAL STATIC HORIZONTAL BRACKET

SKU Q-DSTHB

DIMENSIONS 10" L x 1.25" H x 1.25" D

### FEATURES

- L-shape bracket
- Compatible with STL Z Series



## STL DUAL STATIC VERTICAL BRACKET

SKU Q-DSTVB

DIMENSIONS 5" L x 2.25" H x 1.25" D

### FEATURES

- L-shape bracket
- Compatible with STL Z Series

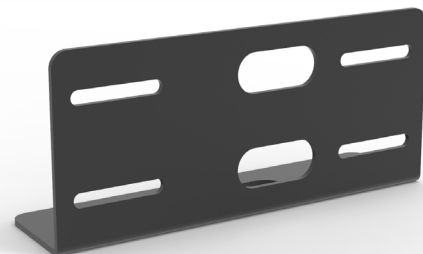

## STL HOOD MOUNT SINGLE STATIC BRACKET

SKU Q-HMB

DIMENSIONS 5.75" L x 2.4" H x 1" D

### FEATURES

- Hood mount bracket
- Compatible with STL Z Series



## STL LICENSE PLATE BRACKET

SKU Q-LPB

HORIZONTAL SETUP DIMENSIONS 15" L x 1.5" H x .75" D

VERTICAL SETUP DIMENSIONS 15" L x 5" H x .75" D

### FEATURES

- Rear/front license plate bracket
- Compatible with STL Z Series
- Allows for vertical or horizontal mounting

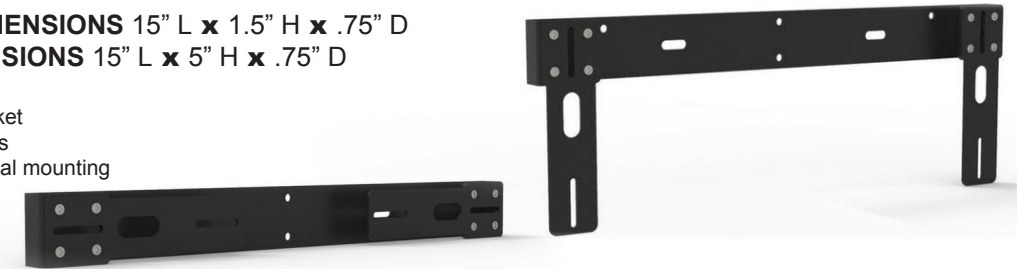

## STL FLARE SERIES SURFACE MOUNT FLANGE

SKU Q-SFFLANGE / Q-BFFLANGE

AVAILABLE COATINGS 

### FEATURES

- Silver or black flange
- Compatible with STL Flare Series

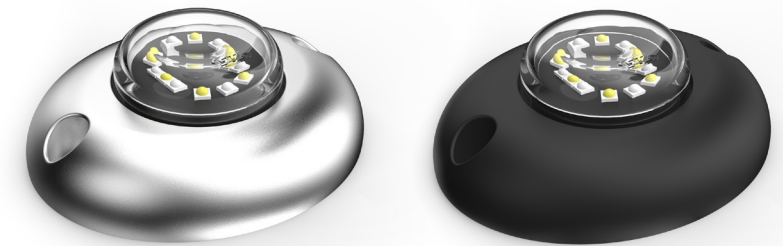

## STL Z SERIES DOUBLE STACK SURFACE MOUNT FLANGE

SKU Q-Z3F / Q-Z4F / Q-Z6F

### FEATURES

- Black double stack flange
- Compatible with STL Z Series
- Offered in 3 sizes:
  - ◊ Z-3/6 Flange dimensions: 3.5" L x 2.5" H x .5" D
  - ◊ Z-4/8 Flange dimensions: 4.25" L x 2.5" H x .5" D
  - ◊ Z-6/12 Flange dimensions: 5.25" L x 2.5" H x .5" D



## STL HALF OCTO BRACKET

SKU Q-HOB

DIMENSIONS 7.6" L x 2.5" H x 1.5" D

### FEATURES

- L-shape bracket
- Compatible with the STL Half Octo

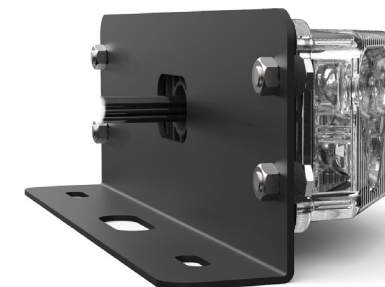

# STL INTERACTIVE PLAYER

You can demo STL products online with our Interactive Player feature. Interactive Players work on Desktop and Mobile devices.

Light Bar Interactive Players...

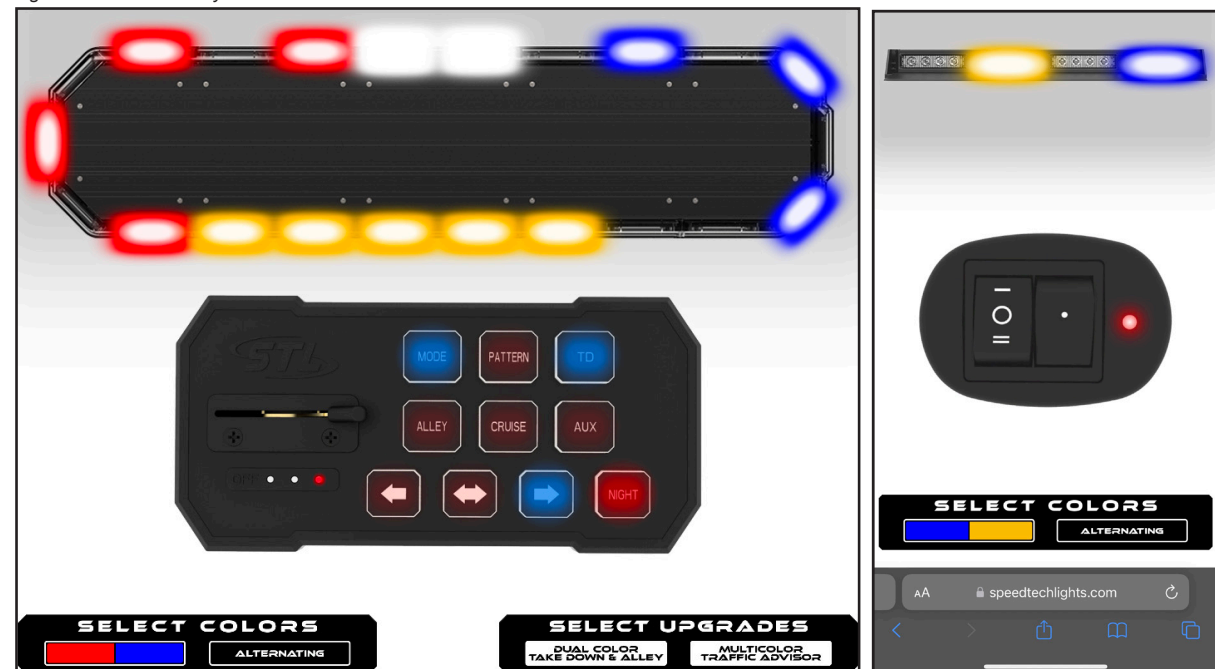

Siren Interactive Players...

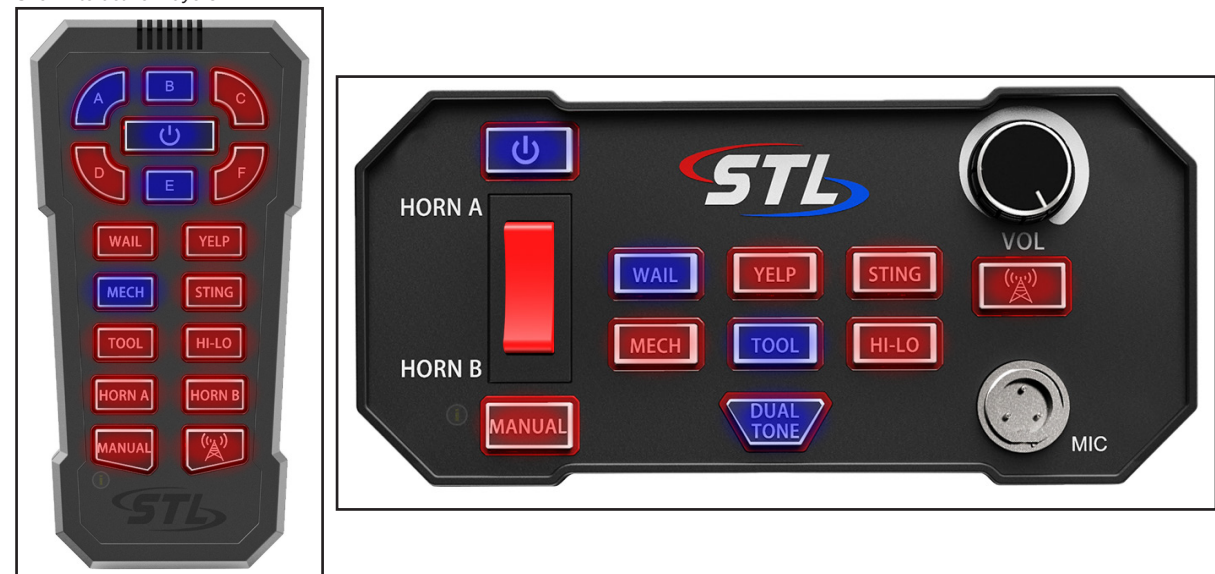

LOOK FOR THIS BUTTON



# STL CUSTOMIZATION TOOL

Customize your lights online to your exact needs using our customize a light bar tool.

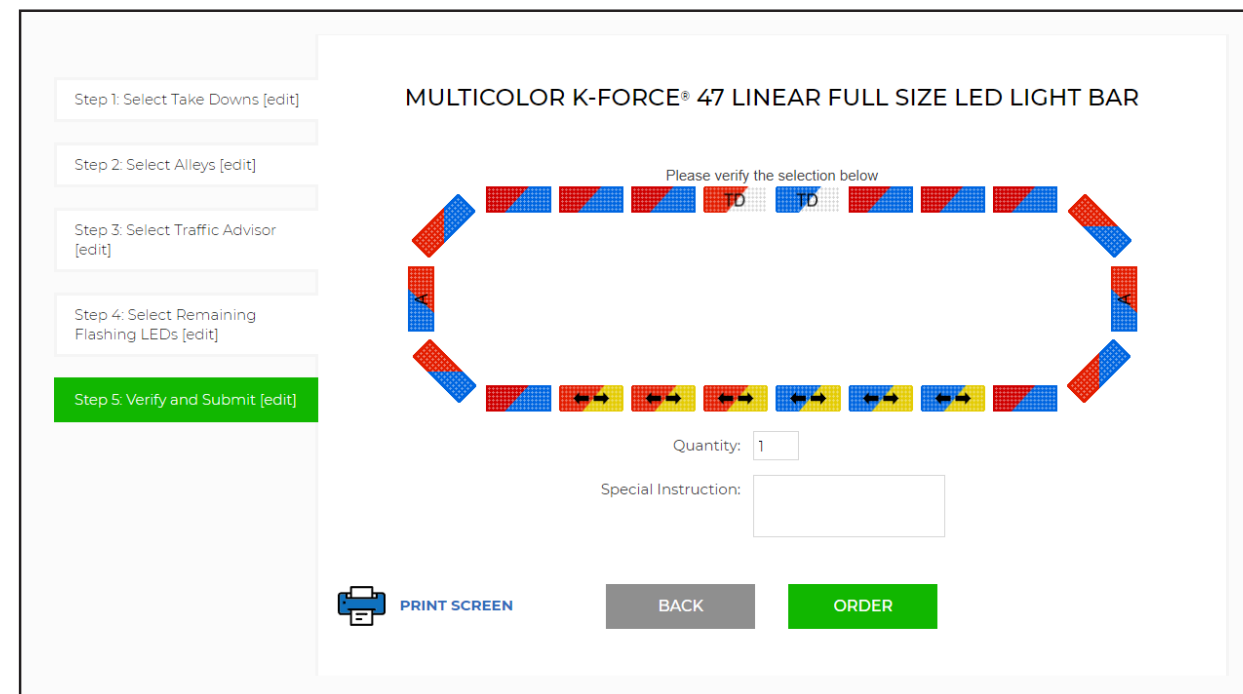

# STL COLOR SELECTOR

Visualize your exact color selection & layout while selecting your color attribute.

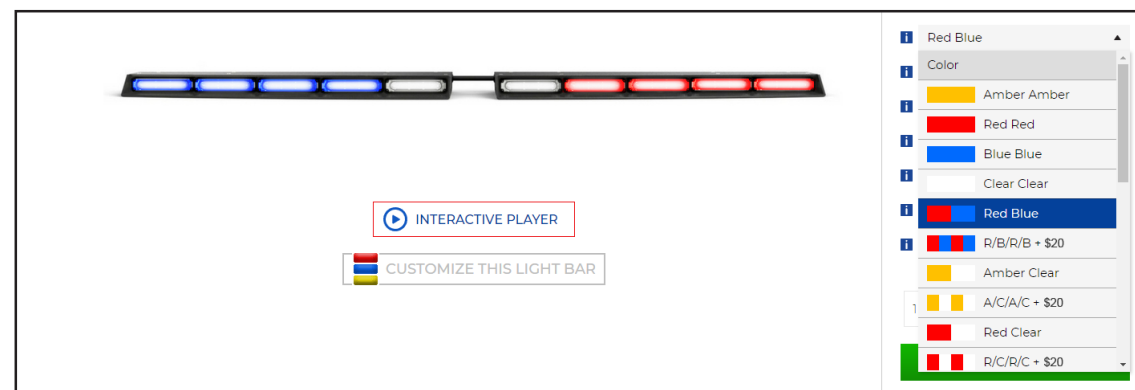





# SPEEDTECH LIGHTS®

2809 BUSINESS PARK DRIVE  
BUDA, TEXAS 78610  
[www.SPEEDTECHLIGHTS.com](http://www.SPEEDTECHLIGHTS.com)



## FOLLOW US

